

A

Possible type of female part "FU"

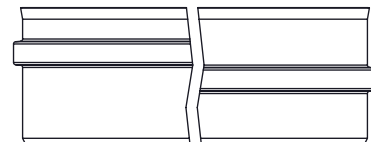

B

C

D

E

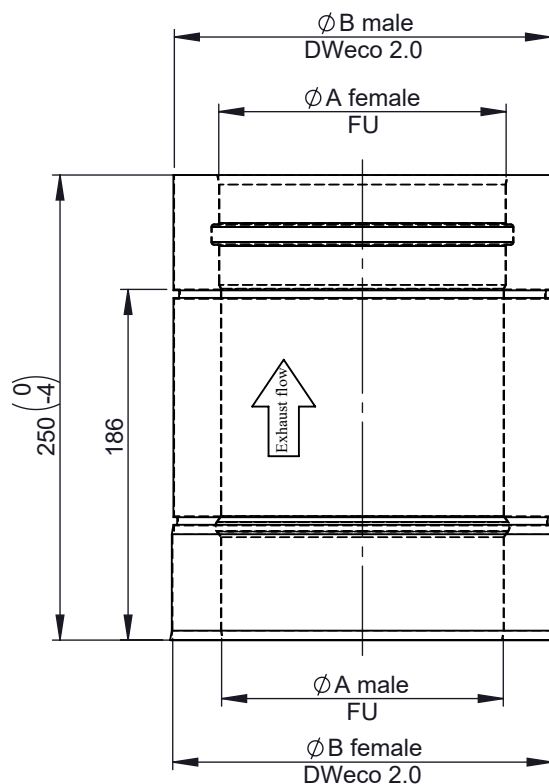

1:10(150)

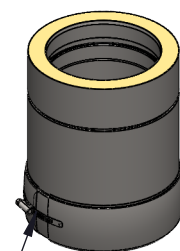

incl. system clamp

\varnothing	0080	0100	0115	0120	0130	0140	0150	0160	0180	0200	0225	0250	0300	0350	0400	0450	0500	0550	0600
A	80	100	115	120	130	140	150	160	180	200	225	250	300	350	400	450	500	550	600
B	130	150	165	170	180	190	200	210	230	250	275	300	350	400	450	500	550	600	650
kg	0,8	1,0	1,1	1,2	1,2	1,3	1,4	1,5	1,6	1,8	2,0	2,2	2,6	3,0	3,4	3,8	4,2	4,6	5,0

notes:

ENCD

DIN ISO 13920 Tolerances B

revisions-no.

A

mm / kg

Jeremias[®]
CHIMNEY SYSTEMS

scale

1:10

format

A4

sheet

1 of 1

F

date	name
drawn by 25.10.19	JMA
checked by 25.10.19	SWA
approved by 25.10.19	JWY
modified by	

description Straight pipe element 250 mm

code 215-DWECO15

drawing-no. 02-35-4200-000

